

Dreh - werkzeuge Turning tools

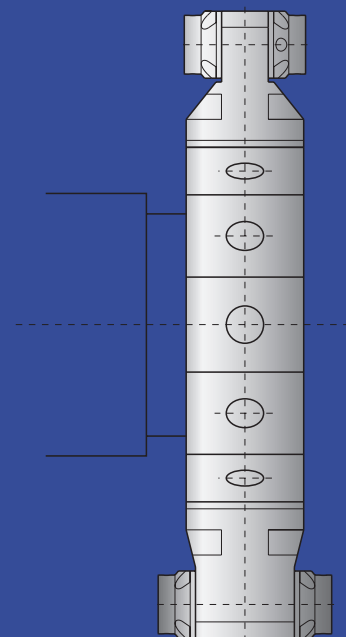

Bohrstangenhalter Typ ADI

Boring bar holder type ADI

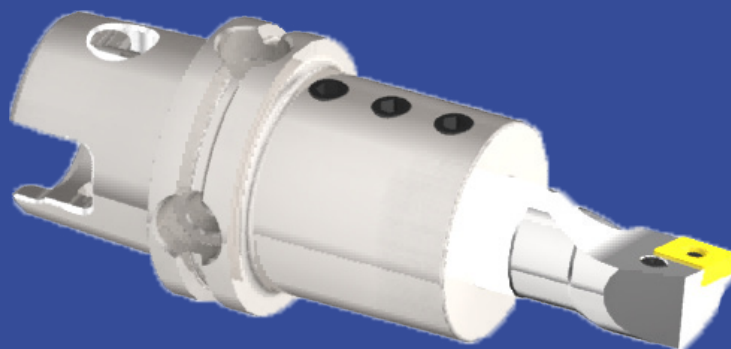
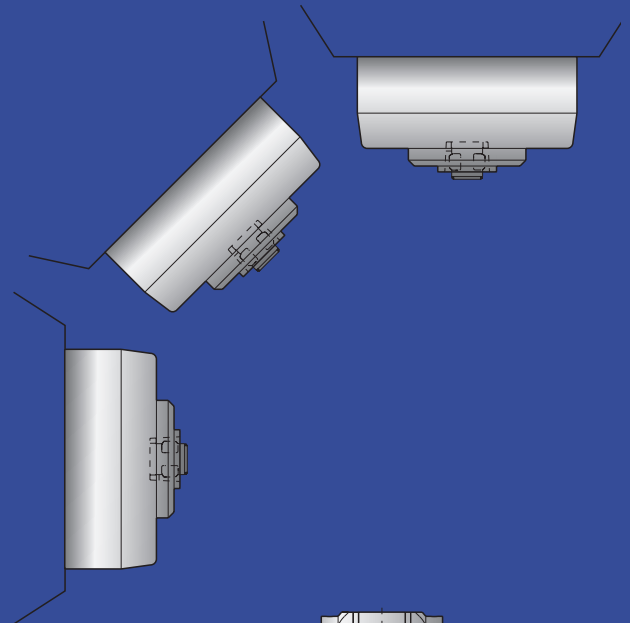
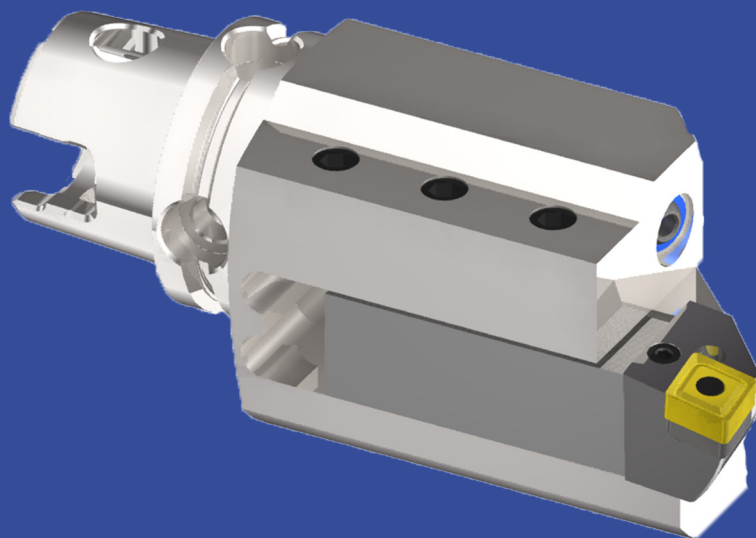

Bestell-Nr. / Order number	D1	D2	A	L
KU6.B06.K01.060	6	34	60	36
KU6.B08.K01.060	8	34	60	36
KU6.B10.K01.060	10	34	60	36
KU6.B12.K01.060	12	36	60	36
KU6.B16.K01.065	16	40	65	51
KU6.B20.K01.070	20	44	70	51
KU6.B25.K01.070	25	50	70	51
KU6.B32.K01.080	32	56	80	66
KU6.B40.K01.105	40	63	105	-

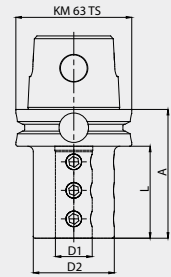

Werkzeughalter axial

Tool holder axial



Bestell-Nr. / Order number	B	Vierkant/ Square	A	L	ØD	R/L
KU6.V20.L11.100	30	20x20	100	70	80	L
KU6.V20.R11.100	30	20x20	100	70	80	R
KU6.V25.L11.130	38	25x25	130	100	102	L
KU6.V25.R11.130	38	25x25	130	100	102	R

Right-hand shown

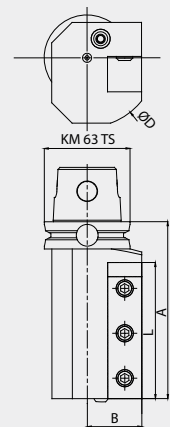

Werkzeughalter axial doppelt

Tool holder axial double

Bestell-Nr. / Order number	B	Vierkant/ Square	A	L	ØD	R/L
KU6.V20.R21.100	30	20x20	100	70	80	R
KU6.V25.R21.130	40	25x25	130	100	102	R

Right-hand shown

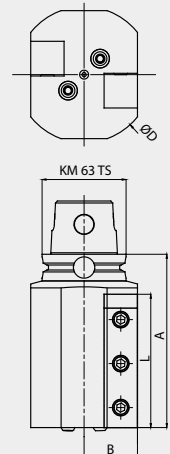

Werkzeughalter axial dreifach

Tool holder axial triple

Bestell-Nr. / Order number	B	Vierkant/ Square	A	L	ØD	R/L
KU6.V20.R31.100	36	20x20	100	70	90	R
KU6.V25.R31.130	40	25x25	130	100	102	R

Right-hand shown

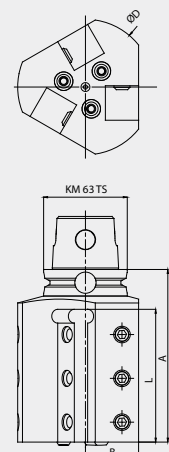

Werkzeughalter radial

Tool holder radial

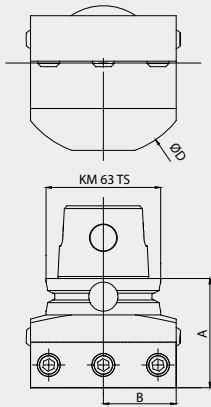

Bestell-Nr. / Order number	B	Vierkant/ Square	A	ØD	R/L
KU6.V20.N11.060	30	20x20	60	90	R/L
KU6.V25.N11.060	40	25x25	60	102	R/L

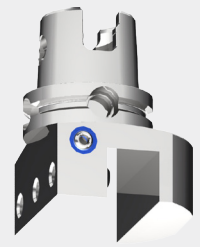

Werkzeughalter 45°

Tool holder 45°

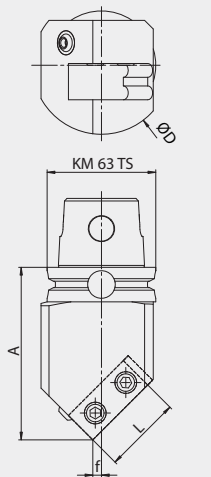

Bestell-Nr. / Order number	f	Vierkant/ Square	A	ØD	R/L
KU6.V20.R12.100	15	20x20	100	80	R
KU6.V20.L12.100	15	20x20	100	80	L
KU6.V25.R12.100	5	25x25	100	102	R
KU6.V25.L12.100	5	25x25	100	102	L

Right-hand shown



Abstechhalter axial

Cut-off block axial

- zur Aufnahme von Stechschwertern
- mit Innenkühlung

- to hold cut-off blades
- with inner coolant supply

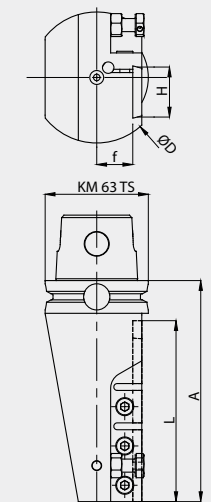

Bestell-Nr. / Order number	B	A	H	L	ØD	R/L
KU6.AM3.K11.135	22	135	32	110	80	R
KU6.AM3.K12.135	22	135	32	110	80	L

Stechschwert / cut-off blade

Right-hand shown

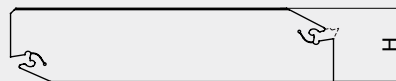

Abstechhalter radial

Cut-off block radial

- zur Aufnahme von Stechschwertern
- mit Innenkühlung

- to hold cut-off blades
- with inner coolant supply

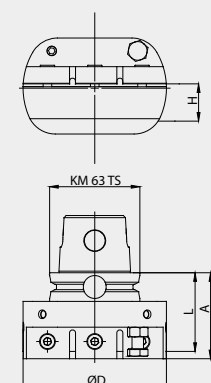

Bestell-Nr. / Order number	A	H	L	ØD	R/L
KU6.AM3.K11.060	60	32	54.5	100	R/L

Stechschwert / cut-off blade

Right-hand shown

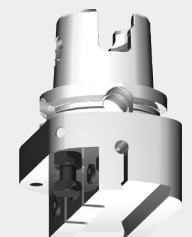



KM-Verlängerung

KM-extension

Bestell-Nr. / Order number	KM TS	KM	A
KU6.KM6.K01.080	63	63	80
KU6.KM6.K01.120	63	63	120

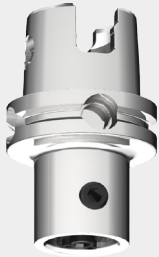
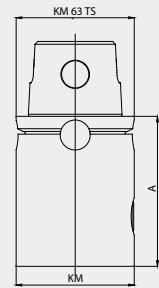

KM-Reduktion

KM-reduction

Bestell-Nr. / Order number	KM TS	KM	A	L
KU6.KM4.K01.060	63	40	60	40

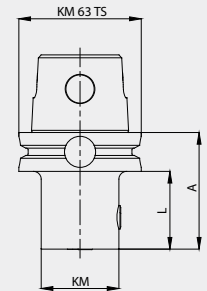

KM-Trennstellenverschluss

KM-blanking plug

Bestell-Nr. / Order number	KM TS	D1	L
KU6.000.001.020	63	63	20

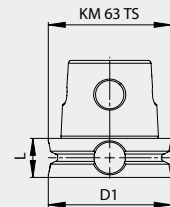

KM-Rohling

KM-blank

Bestell-Nr. / Order number	KM TS	D1	L
KU6.Ro6.001.200	63	63	200
KU6.Ro1.001.150	63	115	150

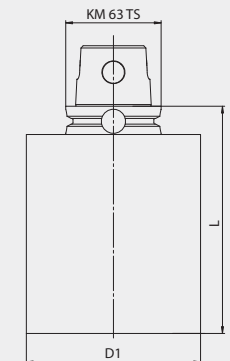

Ersatzteile / Zubehör

Spare parts / Accessories

Für Werkzeughalter/ Für Bohrstangenhalter For tool holder/ For boring bar holder	Bestell-Nr. / Order number	Klemmschraube/ Clamping screw	Dimension
xxx.V20.xxx.xxx	ERU.GS6.001.018		M10 x 18
xxx.V25.xxx.xxx	ERU.GS7.001.025		M12 x 25
xxx.B06.xxx.xxx	ERU.GS4.001.010		M 6 x 10
xxx.B08...B12.xxx.xxx	ERU.GS5.001.010		M 8 x 10
xxx.B16...B40.xxx.xxx	ERU.GS6.001.012		M10 x 12